

MODEL:
RH-S65A-SSVR
RH-S75A-SSVR
RH-S95A-SSVR

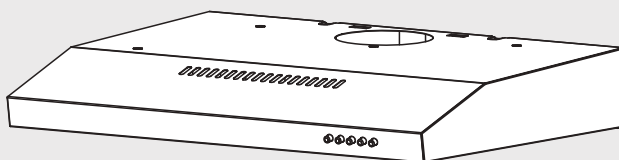

Slim Line Hood
Operation / Installation Manual

Rinnai

CONTENTS

Safety warnings	2
Appliance specifications	4
Installation	5
Operation	6
Maintenance and care	7
Troubleshoot	8



IMPORTANT

To register your product warranty, please paste the serial numbers stickers enclosed with the packaging on your warranty card.

Please contact your local Rinnai Customer Care Centre should you require further assistance.

Version: 2019.08

SAFETY WARNINGS

Please read this user manual thoroughly before attempting to use this appliance for the first time. This manual contains important information on safe installation, use and care of the appliance. Keep these instructions for reference and pass them on to future user.

Unpacking

- Do not use the appliance if there are obvious signs of transportation damage.
- If the power supply cord is damaged, it must be replaced by the manufacturer, its service agent or qualified technician to avoid hazard.
- Please ensure that young children do not play with plastic bag packaging.

For the installer

- The extractor hood can be installed over gas and electric cook top. Minimum installation height from the bench top to the bottom of the hood is 700mm (gas range) and 550mm (electric range) (Fig. 1).

For the user

- The extractor hood is designed for domestic use to eliminate unpleasant odors from the kitchen. Do not use the hood for uses other than its specific purpose.
- Do not allow young children to play with or operate the appliance. Supervise its use by the elderly or infirm.
- Installation and repair should be attempted by qualified technical personnel only.
- It is dangerous to modify any part of this appliance. Tampering with electrical connections or mechanical parts can cause operation faults and may put the user at risk.
- Never leave high naked flames under the extractor hood when it is in operation. Always cover lit burners with cookware.

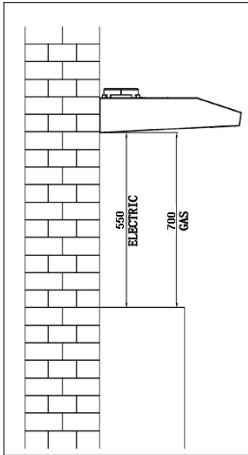

Fig. 1

- Always mount the extractor hood over the center of the hob.
- Ensure that the appliance is installed in a location with good permanent ventilation.
- When making the electrical connections, check that
 - the mains voltage and frequency corresponds to the technical information shown on the rating plate.
 - Electrical connection must be made in accordance to local standards only. Check that the voltage in your area is correct before plugging in.
- Use an electrical connector with earth that is correct for your location. The electrical connection of this appliance must be connected to earth (*where applicable*):
 - Green & Yellow = EARTH; Blue = NEUTRAL; Brown =LIVE
- Ducted mode:
 - Connect the extractor hood to the exhaust duct through a pipe of minimum Ø120mm. Use the shortest and straightest duct route possible.
 - Do not connect the extractor hood to exhaust ducts carrying combustion fumes.
 - Arrange proper ventilation if the extractor hood is used in conjunction with other appliances which are not supplied by electrical power e.g. gas burning appliances. The kitchen must have a direct opening to the outside in order to allow entry of fresh air.

Note: The manufacturer accepts no responsibility for complaints attributed to the design and layout of the pipe work.

- Do not flambé or grill with an open flame directly under the extractor hood. Flames could be drawn up into the hood by the suction and the grease filters may catch fire.
- Monitor cooking continuously as overheated oil increases the risk of self-ignition.
- Do not operate the extractor hood without a grease filter.
- It is important to clean and/or replace the filters at appropriate intervals.
- Grease deposits build-up increases the risk of fire.
- Always disconnect the unit from the power supply before carrying out any cleaning or maintenance work on the hood.
- Ensure that the power supply chord is free from any heat source or sharp objects.
- Multiple plugs and extension cables must not be used. Overloading is dangerous and may cause a fire hazard.

Disposal

- This appliance and its packaging are environmentally friendly and recyclable. Please help us to care for the environment by disposing the packaging in a proper manner and recycling any old appliances.
- Before disposing an old appliance, disconnect it from the power supply and cut the power supply cord to prevent hazards.

The manufacturer will not be held liable for any damages resulting from improper installation nor failure to adopt proper safety measures during installation and operational use of the appliance.

SPECIFICATIONS

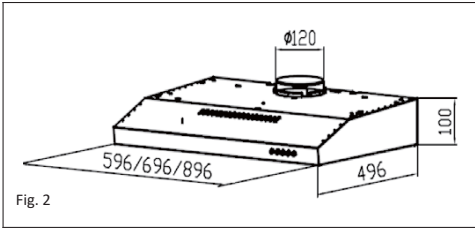

Fig. 2

	RH-S65A-SSVR	RH-S75A-SSVR	RH-S95A-SSVR
Voltage	220V-240V~ 50/60Hz		
Power of Motor	2 x 75W	2 x 75W	2 x 75W
Power of lamps	1 x 2W	2 x 2W	2 x 2W
Cable length	1m		
Appliance Dimension	596*496*100 (W x D x H)	696*496*100 (W x D x H)	896*496*100 (W x D x H)
Note: The manufacturer reserves the right to change any technological improvement or modification without prior notice.			

Components

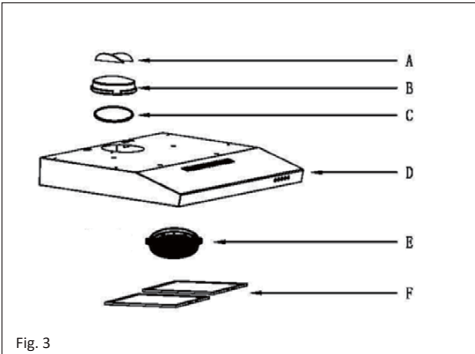

Fig. 3

Ref	Qty	Product components
A	2	Non return flap
B	1	Outlet Connector
C	1	Outlet Cover
D	1	Hood Body
E	2	Charcoal filter
F		Grease Filters
	2	For RH-S65A-SSVR & RH-S75A-SSVR
	3	For RH-S95A-SSVR
Ref	Qty	Installation components
	6	ST4 x 25
	6	Ø8 x Ø6 wall plug
Qty	Documentation	
	1	Operation / Installation Manual
	2	Installation Diagram
	1	Warranty sticker

INSTALLATION

This appliance can be installed in ducted or recirculation mode.

Ducted mode (Fig. 4)

- In ducted mode, the extractor hood fan extracts the cooking vapors and passes them through the grease filter. The air then flows to the outside.
- The grease filter absorbs the solid particles in the cooking vapors.
- In this mode, **only grease filters are installed (charcoal filter is optional).**

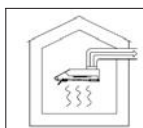

Fig. 4

Recirculation mode (Fig. 5)

- In recirculation mode, the extractor hood fan extracts the cooking vapors which are purified in the grease filter and charcoal filter.
- The purified air is then recirculated into the kitchen via a vent opening in the hood.
- The grease filter absorbs the solid particles in the cooking vapors. The charcoal filter is designed to absorb cooking odor.
- In this mode, **both grease filters and charcoal filter are installed.**

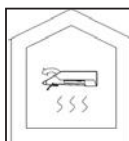

Fig. 5

Operating mode setting (Fig. 6 & 6.1)

Please set the operating mode of your appliance before installation.

- Remove grease filter
- For **ducted mode**, slide the lever to position as shown (Fig. 6)
- For **recirculation mode**, slide the lever to position as shown (Fig. 6.1)
- Refit grease filter

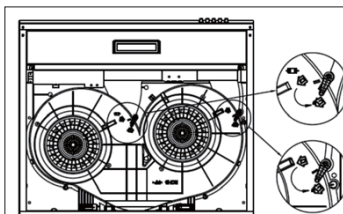

Fig. 6

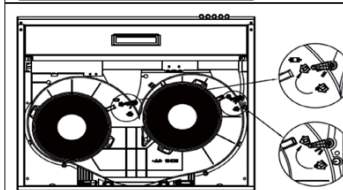

Fig. 6.1

Connection (Fig. 7)

- For **ducted mode**:
 - Use $\varnothing 120\text{mm}$ pipe (flexible if possible) and fix it with a pipe-tightening ring (not provided) at the reduction fitting.
 - Connect the pipe to the outdoor duct.
 - Remove charcoal filters and use only grease filter for more powerful suction.
- For **recirculation mode**:
 - Insert the charcoal filters.

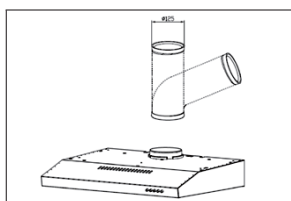

Fig. 7

Wall mounting (Fig. 8)

Do ensure that the appliance is mounted on a solid surface which could withstand the appliance's weight.

- According to your installation height, stick the installation diagram on the wall (see A). Drill 4 (four) $\varnothing 8\text{mm}$ holes (see 1&2). Insert wall plugs in the wall.
- Take off the installation diagram.
- Insert and loose screw in 2 (two) screws ST4x 25 to wall (see B in hole 1). Leave approximately 1cm gap from wall surface.
- Hang the extractor hood onto the screws and tighten firmly with 2 (two) screws ST4x 25 in hole 2.

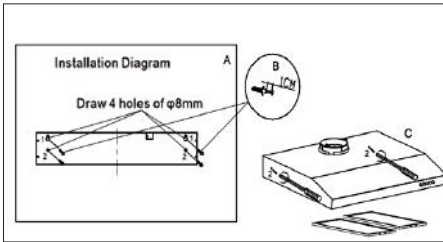

Fig. 8

Installation must be performed by qualified personnel only. The manufacturer declines all responsibility for improper installation and does not accept responsibility for appliance warranty in the event of damage caused by incorrect installation.

Fitting in to wall cabinet (Fig. 9)

- For ducted mode, cut a minimum of $\varnothing 140\text{mm}$ hole on the cabinet base.
- Lift the hood into the cabinet from below.
- Secure 4 (four) screws ST4 x 25 firmly to cabinet.

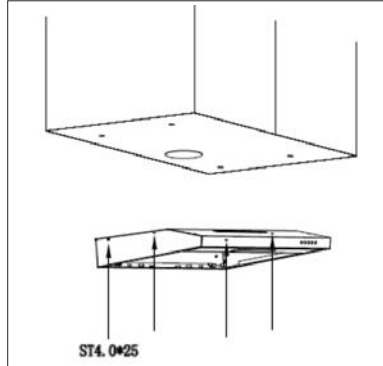
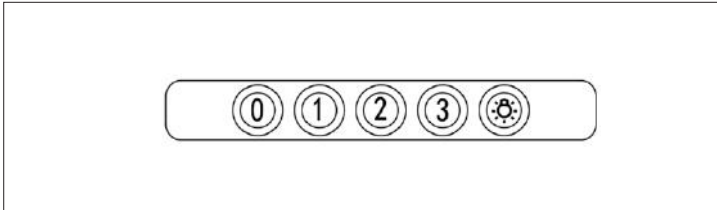

Fig. 9

OPERATION

To achieve better air extraction, we recommend you to switch on the blower a few minutes before starting to cook. Leave it on for approximately 15 minutes after cooking or till all cooking smell is completely removed.

Switch control



- ① **POWER** : Press to turn power ON/OFF.
- ① **LOW SPEED** : Press to select low speed.
- ② **MEDIUM SPEED** : Press to select medium speed.
- ③ **HIGH SPEED** : Press to select high speed.
- ⚙️ **LIGHT** : Press to turn on/off light.

MAINTENANCE AND CARE

Disconnect the power supply cord before carrying out any cleaning or maintenance activities. It is important to clean and/or replace the filters at appropriate intervals as grease deposits build-up increases the risk of fire. Do not operate the extractor hood without grease filter.

Grease filter (Fig. 10)

- Grease filters are used to absorb the grease particles formed during cooking process. The filters must be removed and cleaned every 4 weeks, depending on how often the appliance is used. Clean the filter either by hand or in the dishwasher.
Note: Take care not to bend the filters during washing.
- If by hand washing, soak the filters in warm detergent solution to simplify the removal of grease. Brush the filters, rinse thoroughly and leave it to dry before refitting.
- If by dishwasher, select an appropriate wash program. Leave it to dry before refitting. *Note:* slight discoloration of the filter may occur.
- Removing and inserting the grease filters:
 - To remove, depress the handle and pull down at the same time.
 - To refit, slot the filter into position. Make sure that handle is visible on the outside.

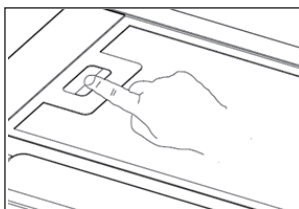

Fig. 10

Charcoal filter (where applicable) (Fig. 11)

- The charcoal filters should be replaced when it is noticeably dirty or discolored, usually after maximum 2 months depending on the conditions of use.
- These filters are not washable and cannot be restored. To ensure that this appliance functions effectively, regular maintenance is necessary as clogged filters restrict airflow and may cause the motor to overheat.

- Removing and inserting the charcoal filter:
 - Remove the grease filters.
 - Remove the saturated charcoal filter from the blower as shown. Release from latch (see A).
 - Fit in the new charcoal filters and lock (see B).

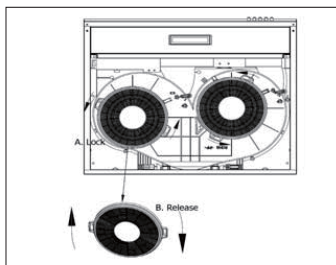

Fig. 11

Cleaning the appliance body

- Clean the extractor hood using warm detergent solution and a soft damp cloth. Wipe dry with a lint-free cloth.
- Avoid using corrosive or abrasive products that could damage the surface.

Light replacement (Fig. 12)

- ⚠ Replace the light with another which has the same characteristics. A higher voltage bulb could damage the electrical unit.
- Removing and replacing the light:
 - Remove grease filters and push out the light.
 - Open the wire connector and disconnect terminal.
 - Replace damaged lights and reconnect the terminal.
 - Reverse the procedure for refitting.

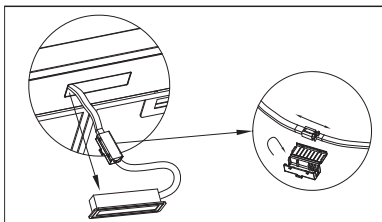

Fig. 12

You are strongly recommended to follow these safety instructions. The manufacturer will not be held liable for any damages to the appliance or any fire hazard due to failure to observe the above safety recommendations.

TROUBLESHOOT

Problem	Possible Cause	Solution
Extractor hood does not function	No electrical supply	Check that plug is connected and main power switch is turned on
Poor airflow	Grease filters clogged with grease build-up	Clean the grease filters and refit when dry
	Charcoal filters clogged with grease build-up	Replace charcoal filters with new sets
Hood suction is not effective	Inadequate ventilation	Ensure that the kitchen is sufficiently ventilated to allow entry of fresh air
	Charcoal filters are not installed	Install charcoal filters for setting in recirculation mode
Motor is running but no airflow	Poor exhaust	Please contact Rinnai Customer Care Service
Whirring sound	Foreign object may be in contact with fan blade	Please contact Rinnai Customer Care Service
Lights are not working	Light bars are blown out	Replace the damaged light
	Light bar connection are loose	Reset the connection

If problem persists after the above checks, please contact Rinnai Customer Care Centre for assistance.

Please quote the model number of your appliance as shown on the rating plate attached to your equipment (Fig. 13).

For service calls under warranty, please note that it is necessary to produce your proof of purchase and valid warranty card.

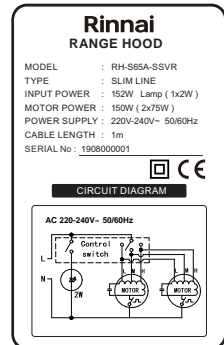

Fig.13 - Rating plate is for illustration purpose only and its specifications vary across models.

Rinnai Customer Care Centres

China | 中国

Guangzhou Rinnai Gas & Electric
Room 2805, No.31 Jianghe Building,
Rinnai Building, Guangzhou, China
广州林内燃气电器有限公司
中国广州天河区天寿路 31 号江河大厦 2805 室
Tel 电话 : (86) 20 3821 7976
Email 邮箱 : grrjdq@gzrinnai.com.cn
URL 网址 : www.gzrinnai.com.cn

Indonesia

PT. Bhakti Idola Tama
Jl. Raya Perjuangan No.21
Komp. Ruko Sastra Graha No.11-13
Jakarta 11530
Tel : (62) 0800 1 889 889 (Customer Care) /
(0815 112 99999 (SMS Center)
Email: customercare_bit@yahoo.com
URL: www.rinnai.co.id

Macau | 澳門

Rinnai Appliance Service Center
Edificio Industrial, 3 andar F.A da Zona Macau
林内爐具服務中心
澳門青洲跨境工業大廈3樓F座
Phone 電話 : +853 2852-7799
Fax 傳真 : +853 2827-0572
URL 网址 : www.rinnai.com.hk/mo

Malaysia

Rinnai (M) Sdn Bhd
D2-3-G & D2-3-1, Block D2, Pusat Perdagangan Dana 1,
Jalan PJU 1A/46, 47301 Petaling Jaya,
Selangor Darul Ehsan, Malaysia
Tel : (60) 3 7832 0037 / 7832 0038 / 7832 0039
Fax : (60) 3 7832 0036
Toll free: 1800-88-8180
Email: customercare@rinnai.com.my
URL : www.rinnai.com.my

Myanmar | မြန်မာ

Myanmar Kowa International Co., Ltd
No.199, Ground Floor, 34th Street (Upper Block),
Kyauktada Township, Yangon, Myanmar
အမှတ် (၁၉၉) ၃၄ လမ်း (အပေါ်ဘလောက်)၊
ကျောက်တံတားမြို့နယ်၊ ရန်ကင်းမြို့။
Tel ဖုန်း : (95-1) 245925 / 246304 / (95-9) 7300 7773
Fax ဖုန်း (၆) : (95-1) 245925
Email အီးမေးလ် : marketing@myanmarkowa.com

Philippines

Mitsui Industrial Corporation
10 Buenaventura St., Cor MacArthur
Highway, Dalandan Valenzuela City,
Philippines
Tel : (63) 2 292 9177 / 292 9179
Fax : (63) 2 292 8187

Singapore

Rinnai Holdings (Pacific) Pte Ltd
61 Ubi Road 1 #02-20 & 21
Oxley Bizhub Singapore 408727
Tel : (65) 6748 9478
Fax : (65) 6745 9240
Email : service@rinnai.sg
URL : www.rinnai.sg

Thailand | ประเทศไทย

Rinnai (Thailand) Co., Ltd. / Lucky Flame Co., Ltd.
61/1 Soi Kingkaew 9, Kingkaew Rd.
Racha Thewa, Bangphli, Samutprakarn 10540, Thailand
บริษัท รินไน (ประเทศไทย) จำกัด
เลขที่ 61/1 ซอยกิ่งแก้ว 9 ถนนกิ่งแก้ว ตำบลราชาเทวะ
อำเภอบางพลี จังหวัดสมุทรปราการ
ประเทศไทย 10540
Tel : (66) 2 3124330-40
Email : lucky02@luckyflame.co.th
URL : www.luckyflame.co.th

Vietnam | Việt Nam

Rong Viet Commerce Company Limited
120 3/2 Street, Ward 12, District 10,
Ho Chi Minh City, Vietnam
Công Ty TNHH Thương Mại Rõng Việt
120 Đường 3/2, Phường 12, Quận 10,
TP. Hồ Chí Minh, Việt Nam
Tel : (84) 8 3862 3409
Fax : (84) 8 5404 1964
Email : info@rongviet-rinnai.com
URL : www.rongviet-rinnai.com